

VL FLEX 52MM SERIES

VL FLEX 52

J1939

USER MANUAL
rev. AB



EN

DE

IT

FR

ES

PT



CONTENT

- Content..... 2**
- Introduction..... 3**
 - Packaging Content..... 3
 - The All-In-One Instrument..... 3
 - Contactless Configuration..... 3
- Safety Information..... 4**
 - Safety During Installation..... 4
 - Safety After Installation..... 5
 - Electrical Connection..... 5
- Installation..... 6**
 - Before the Assembly..... 6
 - Installation with Spinlock..... 7
 - Flush Mounting..... 8
- Connections..... 9**
 - Pinout..... 9
 - J1939 Connection..... 9
 - Frequency Input..... 10
 - Resistive Input..... 10
- Configuration..... 11**
 - VL Flex Configurator App..... 11
 - System Configuration..... 11
 - Supported Configurations..... 15
- Display Layout..... 17**
 - Single Layout..... 17
 - Dual Layout..... 17
 - Alarm Display..... 18
- Technical Data..... 19**
 - Datasheet..... 19
- Accessories..... 20**

INTRODUCTION

PACKAGING CONTENT

Part Number	Description
B00086001	1x VL Flex J1939
A2C5205947101	1x 52 mm Mounting Spinlock
A2C59512947	1x 8-pole cable
B000100	1x Safety instructions

THE ALL-IN-ONE INSTRUMENT

The VL Flex device can easily be configured to be the instrument you need - thanks to its sun-readable 1.44" TFT display embedded into a standard 52 mm instrument housing.

The supported analog inputs allow you to directly read from the sensors. In addition, the J1939 and the LIN 2.0 interfaces make it possible for the VL Flex to read from the digital networks as well.

The simple but effective graphic design can be set up in a single or dual layout, presenting the data in a clear and intuitive form, while the colored bar graph and the alarm display allow you to visually understand your data.

CONTACTLESS CONFIGURATION

Thanks to the contactless configuration you can setup your all-in-one instrument with a simple tap!

Launch the companion App and define your settings through the user-friendly interface, then simply hold your mobile device in proximity of the VL Flex device to transfer the configuration.

Thanks to the embedded passive antenna the configuration can be done powerless.

SAFETY INFORMATION

WARNING

- No smoking! No open fire or heat sources!

- The product was developed, manufactured and inspected according to the basic safety requirements of EC Guidelines and state-of-the-art technology.
- The instrument is designed for use in grounded vehicles and machines as well as in pleasure boats, including non-classified commercial shipping.
- Use our product only as intended. Use of the product for reasons other than its intended use may lead to personal injury, property damage or environmental damage. Before installation, check the vehicle documentation for vehicle type and any possible special features!
- Use the assembly plan to learn the location of the fuel/hydraulic/compressed air and electrical lines!
- Note possible modifications to the vehicle, which must be considered during installation!
- To prevent personal injury, property damage or environmental damage, basic knowledge of motor vehicle/shipbuilding electronics and mechanics is required.
- Make sure that the engine cannot start unintentionally during installation!
- Modifications or manipulations to veratron products can affect safety. Consequently, you may not modify or manipulate the product!
- When removing/installing seats, covers, etc., ensure that lines are not damaged and plug-in connections are not loosened!
- Note all data from other installed instruments with volatile electronic memories.

SAFETY DURING INSTALLATION

- During installation, ensure that the product's components do not affect or limit vehicle functions. Avoid damaging these components!
- Only install undamaged parts in a vehicle!
- During installation, ensure that the product does not impair the field of vision and that it cannot impact the driver's or passenger's head!
- A specialized technician should install the product. If you install the product yourself, wear appropriate work clothing. Do not wear loose clothing, as it may get caught in moving parts. Protect long hair with a hair net.
- When working on the on-board electronics, do not wear metallic or conductive jewelry such as necklaces, bracelets, rings, etc.
- If work on a running engine is required, exercise extreme caution. Wear only appropriate work clothing as you are at risk of personal injury, resulting from being crushed or burned.
- Before beginning, disconnect the negative terminal on the battery, otherwise you risk a short circuit. If the vehicle is supplied by auxiliary batteries, you must also disconnect the negative terminals on these batteries! Short circuits can cause fires, battery explosions and damages to other electronic systems. Please note that when you disconnect the battery, all volatile electronic memories lose their input values and must be reprogrammed.
- If working on gasoline boat motors, let the motor compartment fan run before beginning work.
- Pay attention to how lines and cable harnesses are laid so that you do not drill or saw through them!
- Do not install the product in the mechanical and electrical airbag area!

SAFETY INFORMATION

- Do not drill holes or ports in load-bearing or stabilizing stays or tie bars!
- When working underneath the vehicle, secure it according to the specifications from the vehicle manufacturer.
- Note the necessary clearance behind the drill hole or port at the installation location. Required mounting depth: 65 mm.
- Drill small ports; enlarge and complete them, if necessary, using taper milling tools, saber saws, keyhole saws or files. Deburr edges. Follow the safety instructions of the tool manufacturer.
- Use only insulated tools, if work is necessary on live parts.
- Use only the multimeter or diode test lamps provided, to measure voltages and currents in the vehicle/machine or boat. Use of conventional test lamps can cause damage to control units or other electronic systems.
- The electrical indicator outputs and cables connected to them must be protected from direct contact and damage. The cables in use must have enough insulation and electric strength and the contact points must be safe from touch.
- Use appropriate measures to also protect the electrically conductive parts on the connected consumer from direct contact. Laying metallic, uninsulated cables and contacts is prohibited.

SAFETY AFTER INSTALLATION

- Connect the ground cable tightly to the negative terminal of the battery.
- Reenter/reprogram the volatile electronic memory values.
- Check all functions.
- Use only clean water to clean the components. Note the Ingress Protection (IP) ratings (IEC 60529).

ELECTRICAL CONNECTION

- Note cable cross-sectional area!
- Reducing the cable cross-sectional area leads to higher current density, which can cause the cable cross-sectional area in question to heat up!
- When installing electrical cables, use the provided cable ducts and harnesses; however, do not run cables parallel to ignition cables or to cables that lead to large electricity consumers.
- Fasten cables with cable ties or adhesive tape. Do not run cables over moving parts. Do not attach cables to the steering column!
- Ensure that cables are not subject to tensile, compressive or shearing forces.
- If cables are run through drill holes, protect them using rubber sleeves or the like.
- Use only one cable stripper to strip the cable. Adjust the stripper so that stranded wires are not damaged or separated.
- Use only a soft soldering process or commercially available crimp connector to solder new cable connections!
- Make crimp connections with cable crimping pliers only. Follow the safety instructions of the tool manufacturer.
- Insulate exposed stranded wires to prevent short circuits.
- Caution: Risk of short circuit if junctions are faulty or cables are damaged.
- Short circuits in the vehicle network can cause fires, battery explosions and damages to other electronic systems. Consequently, all power supply cable connections must be provided with weldable connectors and be sufficiently insulated.
- Ensure ground connections are sound.
- Faulty connections can cause short circuits. Only connect cables according to the electrical wiring diagram.
- If operating the instrument on power supply units, note that the power supply unit must be stabilized and it must comply with the following standard: DIN EN 61000, Parts 6-1 to 6-

INSTALLATION

WARNING

Before beginning, disconnect the negative terminal on the battery, otherwise you risk a short circuit. If the vehicle is supplied by auxiliary batteries, you must also disconnect the negative terminals on these batteries! Short circuits can cause fires, battery explosions and damages to other electronic systems. Please note that when you disconnect the battery, all volatile electronic memories lose their input values and must be reprogrammed.

BEFORE THE ASSEMBLY

1. Before beginning, turn off the ignition and remove the ignition key. If necessary, remove the main circuit switch

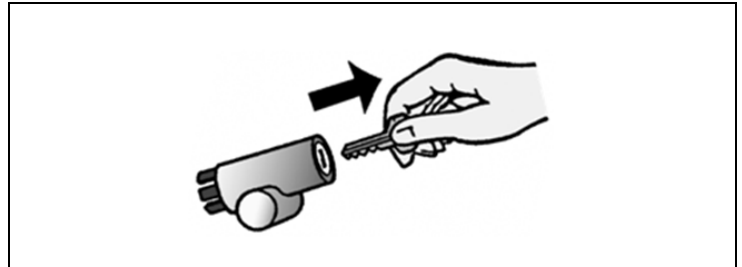

2. Disconnect the negative terminal on the battery. Make sure the battery cannot unintentionally restart.

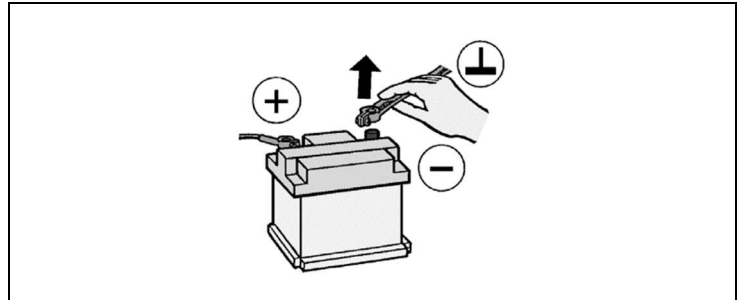

INSTALLATION WITH SPINLOCK

Conventional assembly. (Instrument is put into the drill hole from the front).

The panel width may be within a range of 0.5 to 20 mm. The drill hole must have a diameter of 53 mm [B].

⚠ WARNING

- Do not drill holes or ports in load-bearing or stabilizing stays or tie bars!
- Note the necessary clearance behind the drill hole or port at the installation location. Required mounting depth: 65 mm.
- Drill small ports; enlarge and complete them, if necessary, using taper milling tools, saber saws, keyhole saws or files. Deburr edges. Follow the safety instructions of the tool manufacturer.

1. Different bezels may be installed as alternatives to the supplied front ring. In this case, gently remove the bezel using a screwdriver [A] and install the new bezel on the instrument and press it on until it is flush with the instrument glass.

Note: the bezel cannot be used after removal since it can be damaged.

IMPORTANT: if installing a chrome bezel, make sure to configure the device BEFORE installing it, as the metallic particles contained in the chrome material might affect the NFC performance!

2. Create a circular hole in the panel considering the devices dimensions. [B]

3. Remove the spinlock and insert the device from the front. [C]

4. Adjust the spinlock as shown in picture [D] according to the panel thickness

5. Carefully screw in the spinlock by hand at least two turns.

6. Insert the connector.

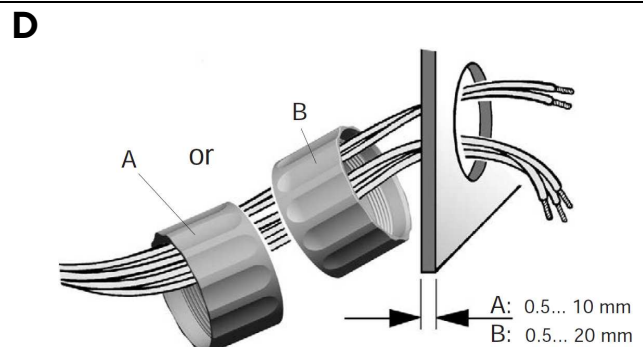
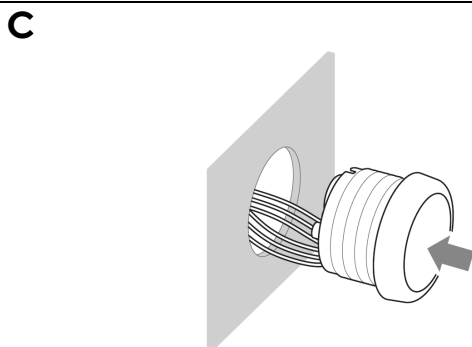
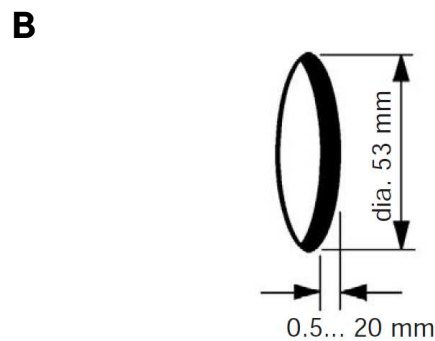
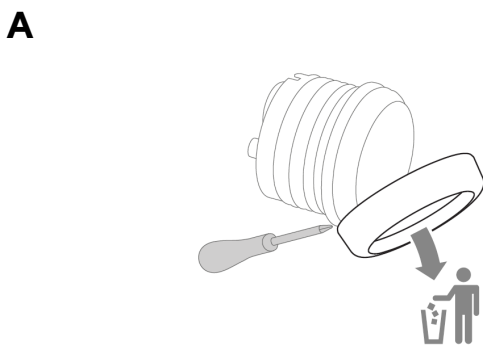

FLUSH MOUNTING

The recommended panel thickness is 1.5 to 3 mm. The drill hole must have a diameter of 48.1 mm. [A]
Ensure that the installation location is level and has no sharp edges.

⚠ WARNING

- Do not drill holes or ports in load-bearing or stabilizing stays or tie bars!
- Note the necessary clearance behind the drill hole or port at the installation location. Required mounting depth: 65 mm.
- Drill small ports; enlarge and complete them, if necessary, using taper milling tools, saber saws, keyhole saws or files. Deburr edges. Follow the safety instructions of the tool manufacturer.

1. Create a circular hole in the panel considering the device dimensions. [A]
2. Remove the spinlock.
3. Gently remove the bezel using a screwdriver. [B]
Note: the bezel cannot be used after removal since damaged.
4. Place the flush mount seal A2C53215640 (not included) on the instrument glass.
5. Put the instrument into the drill hole from the back [C].
6. Adjust the instrument so that the gauge is level and fasten it to the stud bolts on the rear side of the panel, using the flush mount fixing bracket A2C59510864 (not included) [D].
7. Insert the connector

A

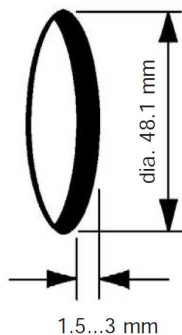

B

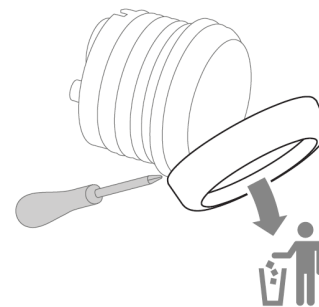

C

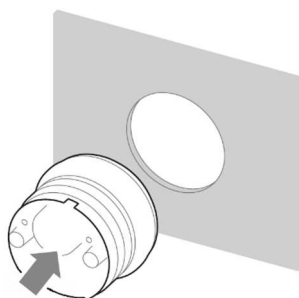

D

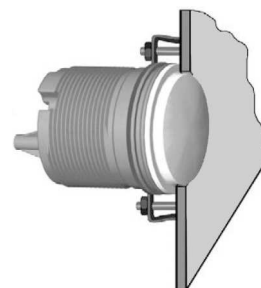

CONNECTIONS

PINOUT

Pin No.	Wire Color	Description
1	Red	KL. 15 - Ignition Plus 12 / 24 V
2	Black	KL. 31 - GND
3	Black / Blue	Frequency input
4	Brown	Resistive input
5	Green	Intelligent Battery Sensor (LIN bus 2.0)
6	Blue / Red	Illumination Day/Night
7	Yellow / Black	SAE J1939 CAN bus High
8	Yellow / Red	SAE J1939 CAN bus Low

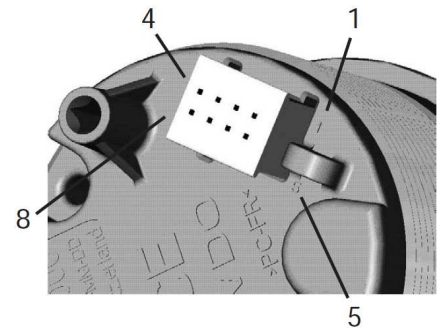

VL Flex 52 rear view
Tyco / Hirschmann 8-pole MQS plug

J1939 CONNECTION

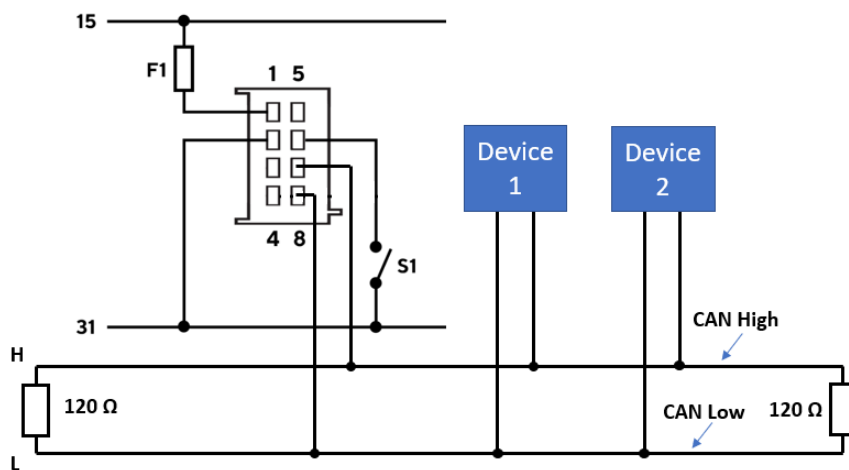

Designations in the wiring diagram:

15 - KL. 15 - Ignition Plus 12/24 V

31 - KL. 31 - GND

F1 - 3A Fuse (not included)

S1 - Illumination switch Day/Night (not included)

H - CAN-Bus J1939 HIGH

L - CAN-Bus J1939 LOW

SAE J1939 is a CAN bus (Data connection) that is often used in engines or machines. It gets applied to connect all the different electrical components (sensors, displays, ...) without the need of many different wires.

It's important, that there is a so-called terminating resistor connecting the ends of the two wires in the physical build up. Those resistors values normally lay somewhere around 120 Ohms

FREQUENCY INPUT

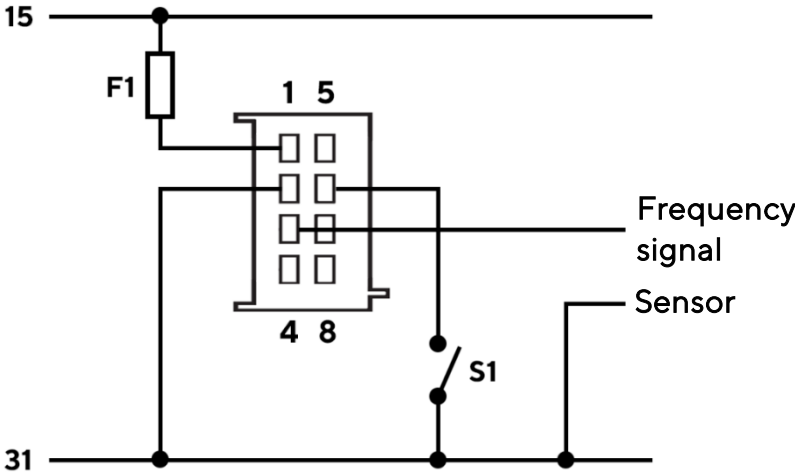

Designations in the wiring diagram:
15 - KL. 15 - Ignition plus 12/24 V
31 - KL. 31 - GND
F1 - 3A Fuse (not included)
S1 - Illumination switch Day/Night (not included)

RESISTIVE INPUT

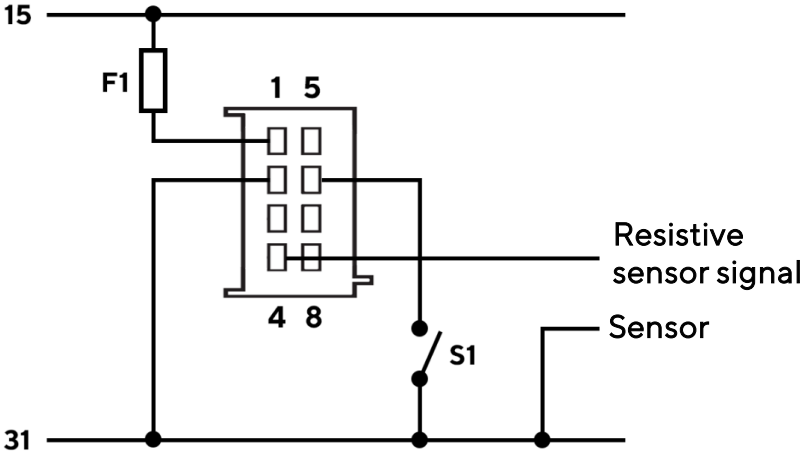

Designations in the wiring diagram:
15 - KL. 15 - Ignition plus 12/24 V
31 - KL. 31 - GND
F1 - 3A Fuse (not included)
S1 - Illumination switch Day/Night (not included)

CONFIGURATION

VL FLEX CONFIGURATOR APP

In order to configurate the VL Flex 52 – J1939, one must set a couple of parameters, such as display layout, the selected sensor and its calibration or the alarm threshold.

This is possible via the smartphone app “VL Flex Industrial”, which can be downloaded free of charge from the according stores.

A simple explanation of the configuration procedure can also be found on the app as an in-app-instruction.

Thanks to the passive embedded NFC receiver, the VL Flex 52 can be configured, as described below, without the need of a power supply.



VL FLEX INDUSTRIAL



SYSTEM CONFIGURATION

The setup of the VL Flex device is an intuitive three-step process.

Please remember that you must READ from the device before being able to manipulate and download the configuration to the instrument.

1. READ



2. CONFIGURE



3. WRITE



1. READ THE VL FLEX CONFIGURATION

Launch the “VL Flex Industrial App” and read the actual configuration of the device by “tapping* the smartphone onto the front lens.

The READ operation is mandatory before the WRITE operation is allowed.

After the readout, the App will be set with the current VL Flex configuration.

NOTE: The antenna position on the smartphone depends on the model.

Please refer to the smartphone manufacturer manual.



2. SELECT A DISPLAY LAYOUT

Use the section “Layout” to choose whether you want to display a single or two values on the device.

The preview picture at the top of the app display will update according to that.

If you choose the dual layout the app expands the settings, so that both fields can be configured.

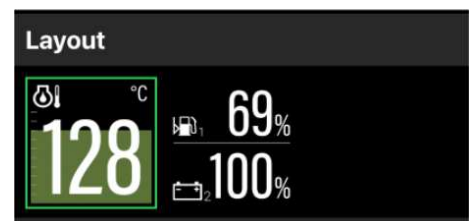

3. SELECT THE DATA TYPE

Use the field “Gauge Type” in the section “Data Selection” to define, which Information should be visible on the VL Flex display.

The chosen parameters J1939 SPN will be displayed in the field “SPN” if the parameter has one. If the value of this parameter is received through the analog input and not through the J1939 interface, this information isn’t significant.

If the dual layout is selected, you can choose the data which should be displayed on the upper and which on the lower part of the display.

Note: You can find the complete list of supported datatypes in the table “Supported Configurations” in this document.

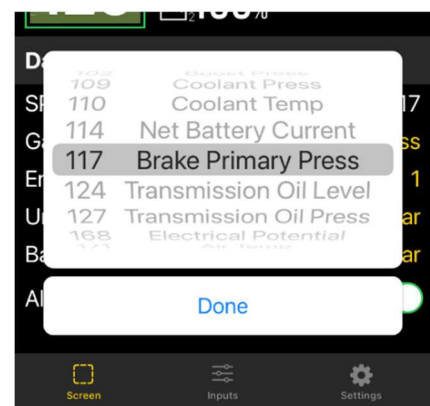
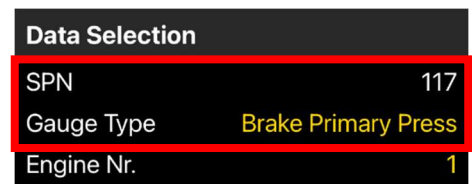

4. SELECT UNIT AND INSTANCE

Define the unit for the displayed data if there is more than one available. (See table “Supported Configurations”)

Set the instance for the displayed data (e.g. engine number or tank number) so they are displayed on the VL Flex correctly.

Note: The defined instance will also be used by the VL Flex if data is received on the SAE J1939 CAN bus.

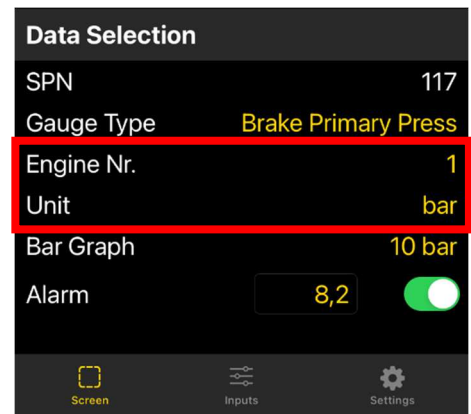

5. SET SCALATION FOR THE BAR GRAPH

To make the bar graph suitable for the expected range of the values, you can now define the biggest value, that should still be displayable on the graph.

This step isn’t applicable for all the data types. The bar graph of the fuel level, for example, has always a range of 0-100% and can’t be set in a different way. In this case the field “Bar Graph” doesn’t show up on the app display.

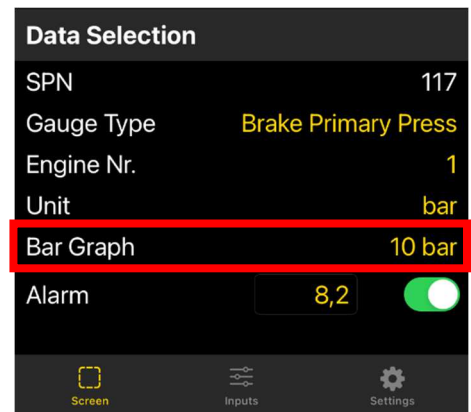

6. CONFIGURE AN ALARM

For many data types, an alarm can be added. (see table “Supported Configurations”)

The alarm can be activated or deactivated with the switch in the according part of the section.

As soon as the alarm is set as active, you can define at which point it should be triggered in the field next to the switch. The unit of the value set into this field is the same as the one set in the previous field.

Note: The direction of the alarm threshold (whether the alarm gets triggered if the value rises over the border or sinks below it) is predefined (See table “Supported Configurations”).

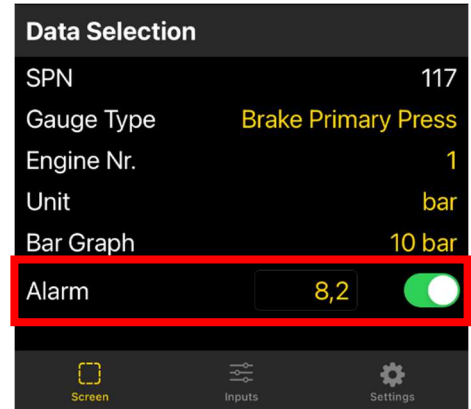

7. CALIBRATE THE SENSOR

The VL Flex assumes the data is received from the J1939 network as a default. This means the analog inputs are usually disabled.

If there is an actual sensor connected to one of the gauges analog inputs (frequency, resistive or IBS-input), it can be calibrated in the register "Input" after activating the input with the switches on the right side.

Note: Depending on the chosen data type, you can either activate the resistive input, the frequency input, the IBS-Input or for some values even no sensor input at all. (See table "Supported Configurations")

If there are two data types selected for the dual layout, which can be measured over the same type of analog input, then you must choose here, which of the two values is connected to the input and which value is received over J1939. (There is always just one analog input of a kind.)

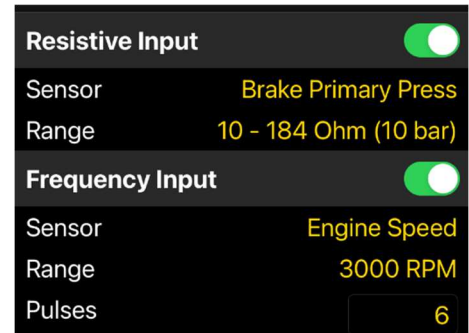

8. SET ILLUMINATION BRIGHTNESS AND CLOCK

The last few configurations can be found in the register "settings".

In this section you can set the display brightness for the day- and night mode by moving the sliders.

Here you can also manage the clock setting.

Note: The clock can only receive the time over the J1939 interface (and only if there is some kind of clock connected to your network). There is no way, the VL Flex can internally maintain the time.

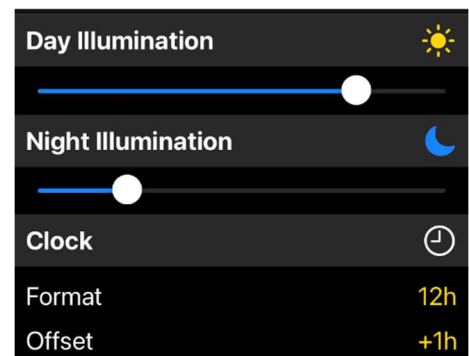









9. WRITE THE CONFIGURATIONS ONTO THE VL FLEX









After you finished choosing your settings, you can load the configurations onto the VL Flex device.

Hit the button "APPLY" in the upper right corner and touch the front lens of the gauge one more time with the backside of your smartphone to transfer the data.



SUPPORTED CONFIGURATIONS

Gauge Type	Unit	Symbol	Resis. Input	Freq. Input	Alarm available	SPN
Engine Speed	rpm		-	✓	Yes (above)	190
Wheel Based Speed	km/h mph	SPEED	-	✓	No	84
Net Battery Current	A		-	-	No	115
Electrical Potential	V		-	-	No	168
Battery SOC	%	SOC	-	-	Yes (below)	-
Battery SOH	%	SOH	-	-	Yes (below)	-
Battery Temperature	°C °F	BATT. TEMP	-	-	Yes (above)	-
Battery Autonomy	h days	BATT. AUT	-	-	Yes (below)	-
Engine Hours	h		-	✓	No	247
Clock	-		-	-	No	964
Catalyst Tank Level	%	DEF / BLUE	-	-	Yes (below)	1761
Percent Load	%	LOAD	-	-	Yes (above)	92
Exhaust Gas Temperature	°C °F		-	-	Yes (above)	173
Fuel Level	%		✓	-	Yes (below)	96
Engine Coolant Temperature	°C °F		✓	-	Yes (above)	110
Coolant Pressure	bar PSI		✓	-	Yes (below)	109

Gauge Type	Unit	Symbol	Resis. Input	Freq. Input	CONFIGURATION	
					Alarm available	SPN
Boost Pressure	bar PSI		✓	-	Yes (above)	102
Oil Pressure	bar PSI		✓	-	Yes (below)	100
Oil Temperature	°C °F		✓	-	Yes (above)	175
Engine Oil Level	%		-	-	Yes (below)	98
Gear Oil Pressure	bar PSI		✓	-	Yes (below)	127
Transmission Oil Level	%		-	-	Yes (below)	124
Gear Oil Temperature	°C °F		✓	-	Yes (above)	177
Air Temperature	°C °F	EXT TEMP	-	-	Yes (below)	171
Total Fuel	L gal (US/UK)	TOTAL FUEL	-	-	No	250
Fuel Rate	L/h gal/h (US/UK)		-	-	No	183
Instantaneous Fuel Economy	L/100km mpg (US/UK) mpL (UK)	FUEL ECON.	-	-	No	184
Odometer	km mi	ODO	-	-	No	245
Brake Pressure	bar PSI		-	-	No	117

The values of the data types, that can neither be received over the resistive input nor over the frequency input, must be transmitted on a digital way. This means on the J1939 CAN bus or for the battery values also the LIN 2.0 bus.

* Supported configurations can be updated at any time. Make sure to always use the latest version of the app.

DISPLAY LAYOUT

SINGLE LAYOUT

A.	<p>Symbol Indicates, which data type is displayed right now.</p> <p>For the data types, which support this function, there is also the instance indicated here.</p>
B.	<p>Unit Shows the unit of the currently displayed data. For some data types it's possible to change the unit in the settings. (See table "Supported Configurations")</p>
C.	<p>Measured value This shows the numeric value of the dedicated measured data. If there aren't any values received for this data type or they are out of range, the display will show "---".</p> <p>Coloured Graphic The coloured graphic in the background is a bar diagram that puts the measured value in perspective. This function isn't supported for all data types. The white lines on the left side show the scalation.</p>

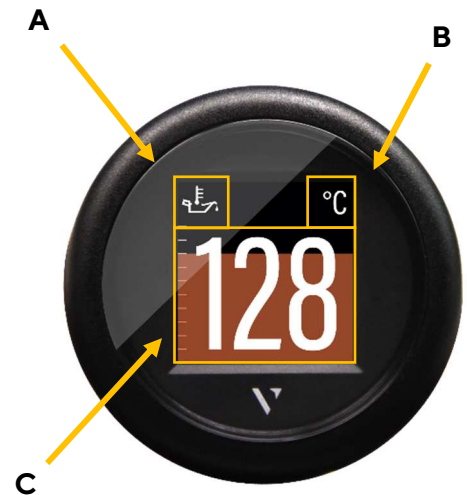

DUAL LAYOUT

A.	<p>Symbol Indicates, which data type is displayed right now.</p> <p>For the data types, which support this function, there is also the instance indicated here.</p>
B.	<p>Unit Shows the unit of the currently displayed data. For some data types it's possible to change the unit in the settings. (See table "Supported Configurations")</p>
C.	<p>Measured Value This shows the numeric value of the dedicated measured data. If there aren't any data received for this data type or the values are out of range, the display will show "---".</p> <p>The bar graph can't be displayed in the dual layout for any value.</p>

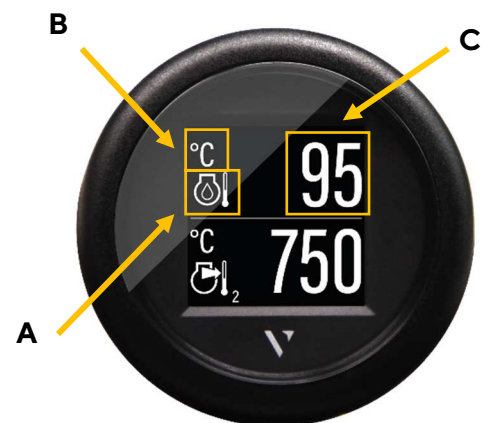

ALARM DISPLAY

**Single Data Layout**

When an alarm occurs the bar-graph turns red and a red alarm symbol is displayed in the top part of the display between the data symbol and the unit.

The display returns to normal operation mode once the alarm is not detected anymore.

**Dual Data Layout**

When an alarm occurs on any of the two displayed data, the numeric digits of the affected data become red.

In the example above, the data at the bottom of the screen (Exhaust Gas Temperature) has an alarm active.

The display returns to normal operation mode once the alarm is not detected anymore.

TECHNICAL DATA

DATASHEET

Display	1.44" sun-readable color TFT display, transmissive
Resolution	125 x 125 Pixels
Nominal Voltage	12 V / 24 V
Operating Voltage	8 - 32 V with overvoltage and reverse polarity protection
Current consumption	Typ. 50 mA with maximum backlight intensity
Analogue ports	Resistive (0 - 400 Ω) Frequency (W, Ind, Hall, Generator)
Digital ports	SAE J1939 - 250 kbit/s LIN 2.0 («Intelligent Battery Sensor»-Interface)
Wireless interface	NFC (Near Field Communication)
Protection class	IP 67 front side (IEC60529)
Lens	PMMA with anti-glare and anti-fog treatments
Housing	Ø52 mm - Polycarbonate (PC), flame retardant (UL94-V0)
Bezels	PC (black, white) or ABS (chrome) - several color and shapes
Operating temperature	-20°C bis +70°C
Storage temperature	-30°C bis +80°C
Connector	Tyco / Hirschmann MQS 8 pole connector
Mounting	Spinlock Nut - locking height 0.5 - 20 mm Optional Studs and Brackets - locking height 2 - 15 mm
Norms	CE, Reach, RoHS

ACCESSORIES

Accessories	Article Number
8 pole cable	A2C59512947
Spinlock Nut 52 mm	A2C5205947101
Flush mount mounting kit	A2C59510864
Flush mount seal	A2C53215640
Bezel - Round Black	A2C5318602701
Bezel - Round White	A2C5318602801
Bezel - Round Chrome*	A2C5318602901
Bezel - Triangular Black	A2C5318602401
Bezel - Triangular White	A2C5318602501
Bezel - Triangular Chrome*	A2C5318602601
Bezel - Flat Black	A2C5318604001
Bezel - Flat White	A2C5318602201
Bezel - Flat Chrome*	A2C5318602301

Visit <http://www.veratron.com> for the complete list of accessories.

* the chrome bezel might interfere with the NFC programming due to the metallic particles contained in the chrome material. Make sure to configure the VL Flex device BEFORE installing the chrome bezel!



veratron AG
Industriestrasse 18
9464 Rüthi, Switzerland

T +41 71 7679 111
info@veratron.com
veratron.com

Any distribution, translation or reproduction, partial or total, of the document is strictly prohibited unless with prior authorization in writing from veratron AG, except for the following actions:

- Printing the document in its original format, totally or partially.
- Copying contents without any modifications and stating Veratron AG as copyright owner.

Veratron AG reserves the right to make modifications or improvements to the relative documentation without notice.

Requests for authorization, additional copies of this manual or technical information on the latter, must be addressed to veratron AG.